

HALLÓ



Welcome to Pingholt Apartments from Center Hotels! We're delighted that you have chosen to stay with us.

This is a self-service apartment equipped with home appliances to offer guests a comfortable stay.

We hope this guest guide can provide you with the information that will be helpful for your stay. The guide includes instruction manuals for appliances that are in the apartment, general information about the building and the area, as well as some tips of places to visit, dine and shop.

Please don't hesitate to contact us if you need any further assistance.

Sincerely,

Pingholt Apartments Team

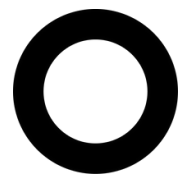

TABLE OF CONTENTS

ABOUT THE PROPERTY

IMPORTANT THINGS TO KNOW

EMERGENCY PROCEDURE

- Fire safety
- Medical Assistance

APARTMENT AMENITIES & APPLIANCE INSTRUCTIONS

- Internet
- Toiletries
- Kitchen Supply
- Linens & Towels
- Hair Dryer
- Iron
- Heater
- Television

ADDITIONAL SERVICES

- Breakfast
- Early check in
- Late check out
- Spa
- Massage
- Laundry Service
- Luggage Service
- Housekeeping Service

APPLIANCE MANUAL

- Washing Machine
- Dishwasher
- Electronic Oven
- Electric Stove Top

CLOSE BY

- Supermarkets
- Pharmacy
- Liquor Store

TRANSPORTATION

- Local Bus & Taxi
- Airport Transfer
- Directions

MUST SEE IN ICELAND

- Tours in Iceland
- Tour pick up point
- Restaurant & Events

GUEST FEEDBACK/REVIEW

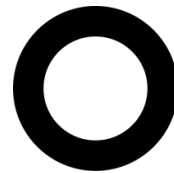

ABOUT THE PROPERTY

Þingholt Apartments from Center Hotels is located at Þingholtsstræti 2 Reykjavík. This aparthotel is in the heart of downtown Reykjavík. It is a 5-minute walk to Harpa Concert Hall and with nearby access to Old Harbour. It is also a 5-minute walk from the iconic Hallgrímskirkja.

Apartments are fully furnished and come with free WIFI, flat screen television, private bathroom and kitchen which is equipped with refrigerator, dishwasher, and electric stove top. Nice touches include a private bathroom, hair dryers, linens, bath sheets, hand soap, shower gel and basic kitchen supplies. The apartments have rustic charm with modern comforts perfect for both short and long stay.

At Þingholt Apartments you can find electronic locks on all rooms.

This aparthotel can be accessed with a unique code which is sent to you via email on the day of arrival. Please note that your code is valid for the entire duration of your stay until 11:00 (11 am) of the day of your check out.

Should you require any assistance, please do not hesitate to contact us directly at lobbythapartments@centerhotels.com or call us at +354 595 8530.

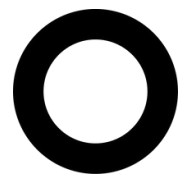

IMPORTANT THINGS TO KNOW

CHECK IN PROCEDURE

Check in is at 14:00 (2 pm).

CHECK OUT PROCEDURE

Check out time is at 11:00 (11 am). Please ensure you have collected all your belongings before leaving the apartment. Late check out at 15:00 (3 pm) can be arranged at an additional cost of 100€. This is subject to availability. Please contact us directly at lobbythapartments@centerhotels.com or call us at +354 595 8530.

ELECTRICITY & POWER VOLTAGE

Most lights in the apartment have dimmers. Please hold the button to increase or decrease the brightness.

For Iceland there are two associated plug types: C and F. Plug type C is the plug which has two round pins and plug type F is the plug which has two round pins, with two earth clips on the side. Iceland operates on a 230V supply voltage and 50Hz.

As voltage can differ from country to country, you may need to use a voltage converter or transformer whilst in Iceland. Most voltage converters and transformers come supplied with plug adapters, so you may not need to buy a separate travel adapter.

ELECTRICAL SWITCHBOARD

There is an electrical switchboard inside the apartment. If the power supply is tripped from plugging a device with a different power voltage, push the switch that is down upwards to get the electricity back on.

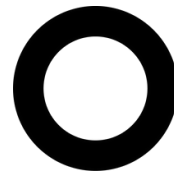

IMPORTANT THINGS TO KNOW

ICELANDIC WATER

The water in Iceland is rich in sulfur and calcium. You might see white color residue on the water and this is completely normal. Be advised that the warm and hot water has a specific smell because of the sulfur, which is harmless but just smells different.

The quality of the drinking water in Iceland is also exceptionally good. It is perfectly safe and recommended to drink the cold water straight from the tap.

HEATER

All apartments are equipped with radiators. To increase or decrease the heating inside the apartment use the white knob on the radiators. Like all radiators in Iceland, they are geothermally heated and take some time to heat up.

SMOKE DETECTOR & FIRE ALARM

All apartments are equipped with smoke detectors. These smoke detectors are sensitive. When cooking please ensure to open the window to avoid having smoke inside the apartment which can trigger the fire alarm.

In case the fire alarm is triggered and it's a false alarm please open the windows to let the smoke out and kindly call +354 595 8530 so that a member of our team can reset the fire alarm system.

NO PARTY POLICY & QUIET HOURS

The aparthotel has a strict NO PARTY policy. Quiet hours are observed from 23:00 (11 pm) to 8:00 (8 am).

NON-SMOKING POLICY

Smoking, including vaping, is strictly prohibited inside the apartments, the common areas, including the corridor, lifts. If you wish to smoke, please do so outside the apartment complex. Additional cleaning fees of 250€ will be charged if the apartment smells of smoke.

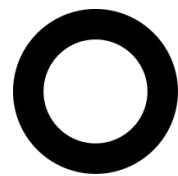

IMPORTANT THINGS TO KNOW

HOUSEKEEPING

Since this is a self service apartment the necessary equipment needed to keep the apartment tidy are already provided. There are no housekeeping services. If guests would like housekeeping services this can be arranged at an extra cost.

Light cleaning (80€ per clean, per day) which includes wiping surfaces in your kitchen and bathrooms, vacuuming, dusting, mopping, and general tidying up as well linen and towel change.

RUBBISH DISPOSAL

There are trash bins inside the apartment. When the trash bin is full, there are large garbage bins located at the back of the building on the ground floor on the right side. Please throw all your rubbish wrapped in plastic bags, into the large bins accordingly.

PARKING

Bingholt Apartment does not have any parking space for guests, but they are welcome to use the public spaces around the building. Thingholt is part of P1.

Charging hours (P1, P2 and P3)

- Monday - Friday 09:00 - 18:00
- Saturday 10:00 - 16:00

Parking rates

- P1 - From 385 ISK per hour
- P2 - From 200 ISK per hour
- P3 - From 200 ISK 1st hour and 190 ISK 2nd hour, 55 ISK each hour thereafter

The parking garages are also available, but they are more expensive as they charge overnight, and they are closed from midnight until 7:00 (guests will not be able to access their car during this time). You can find more information about the street parking, multi story car parks, etc. In: <http://www.bilastaedasjodur.is/english/on-street-parking>.

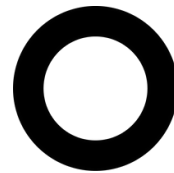

IMPORTANT THINGS TO KNOW

MAINTENANCE SUPPORT

In case there are major maintenance issues in the apartment please call +354 595 8530 or please use the phone in the lobby and you will be directed to our guest services support agent. We will arrange a maintenance personnel to check on the issue. Alternatively please send an email to lobbythapartments@centerhotels.com.

EMERGENCY NUMBER

For serious situations call 112. To get a non-urgent medical opinion, please call 1770.

ASSISTANCE WITH YOUR RESERVATION

For questions regarding amendment or cancellation of reservation please contact our reservations department on thapartments@centerhotels.com or +354 595 8582

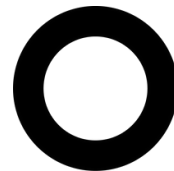

EMERGENCY PROCEDURE

FIRE PRECAUTIONS

Please study the emergency exit route which is placed on the inside of your bedroom door. If a fire alarm is sounded, please evacuate the apartment immediately - do not use the elevators and leave the hotel via the shortest exit. Guests are advised to gather outside the building's front exit and wait for further instructions. If a fire breaks out in your room please break the emergency button glass, found in the hall on each floor and then evacuate the building immediately.

MEDICAL ASSISTANCE

If emergency medical assistance is required please contact the emergency number 112. To get a non urgent medical opinion, please call 1770.

- Regarding heart problems visit Hjartagátt at Landspítali or call them tel. 543 1000.
- For other sickness or illnesses, please contact Heilsugæslan Vesturgata, tel. 585 2600. Open from 08:00-15:30. Nurse assistance with advice from a doctor on duty costs 9300 ISK. Or between 16:00-18:00 guests can book a doctor's appointment and that costs 13.800 ISK.
- In general, if a guest is unwell and the pharmacy is closed, they will have to be directed to the Emergency room. The cost will depend on the guest's country and/ or insurance policy.
- From 17:00-23:30 on weekdays guests can go to Læknavaktin. On weekends it is open from 09:00-23:30. Tel. 1770. Guests can also call this number to get a medical opinion over the phone.
- For emergency dental service please call 426 8000.

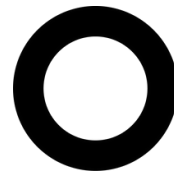

ROOM AMENITIES

INTERNET ACCESS

The internet is complimentary for all guests staying at the apartment. Wireless internet connection is available in the entire building. A password is required to access the internet.

- Network name: centerhotels-guest
- Password: centerhotels

After you have connected to the network, you may need to open a new browser and click continue.

TOILETRIES

A starter toiletry pack is provided upon arrival. We offer body wash and shampoo.

KITCHEN SUPPLY

Basic kitchen supply and instant coffee & tea are provided. Pots, pans, toaster, kettles, plates and cutleries are also available.

LINENS & TOWELS

Apartments are provided with linens and towels. The linens and towels can be replaced by housekeeping service at an extra cost.

HAIR DRYER

All apartments are equipped with hair dryers.

IRON & IRONING BOARD

All apartments are equipped with iron & ironing board.

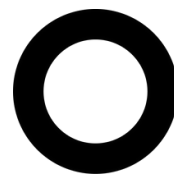

ROOM AMENITIES

HEATER

There is a radiator in each room: the knob can be found on either side and can be adjusted from 0 (cold) to 5 (hot). In Iceland there is no air conditioning.

TELEVISION

Each room at the hotel is equipped with a flat screen TV. There are streaming programs such as Netflix and Amazon Prime that guests can use to access their accounts.

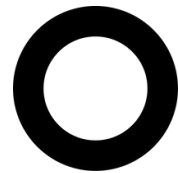

ADDITIONAL SERVICES

BREAKFAST

Breakfast can be purchased at 3500 ISK per person. The breakfast is served at Thingholt by Center Hotels (the building across the road). Breakfast is served from 07:00 - 10:00 every day. For a better experience, we advise that guests book the date and time they would like to have breakfast.

Please send an email to lobbythapartments@centerhotels.com to book a breakfast option. Payment can be made with the front desk agent of Thingholt by Center Hotels.

EARLY CHECK IN

Guaranteed check in time is 14:00 (2 pm). Early check in cost is 50€. This is subject to availability.

LATE CHECK OUT

Check out time is 11:00 (11 am). Guests can request late check out until 15:00 (3 pm) for 100€. This is subject to availability on the day of check out.

SPA

Our sister hotel Thingholt by Center Hotels offers a lovely spa called Isafold Spa. Isafold Spa is equipped with a steam room, hot tub, fitness room and a treatment room for massages. Changing rooms are located in the spa. The entrance fee is 25€ or 3900 ISK per person per stay.

MASSAGE

A range of massages are also available, at different prices:

- Relaxing massage: 9900 ISK (25 min) / 13900 ISK (50 min)
- Traditional massage: 9900 ISK (25 min) / 13900 ISK (50 min)
- Deep Tissue massage: 9900 ISK (25 min) / 13900 ISK (50 min)

SPA treatments are booked through the reception at Thingholt by Center Hotels. It is recommended that 24 hour advance notice is provided.

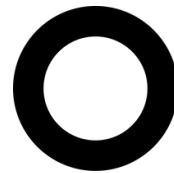

ADDITIONAL SERVICES

LAUNDRY SERVICE

There are laundry bags inside the apartment, guests can have their washing done at Thingholt by Center Hotels at an extra cost of 10.000 ISK. The laundry must be dropped at the reception at Thingholt by Center Hotels. Washed laundry will be ready in 24 hours. Guests must sort out their own laundry according to color and notify the front desk of any special instructions. Laundry is restricted to washing only, ironing or dry cleaning is not possible.

LUGGAGE STORAGE

Guests of Þingholt Apartments can store their luggage at Þingholt by Center Hotels for an extra fee of 20€ per day.

ROMANTIC PACKAGE

Included is a bottle of sparkling-, red or white wine and sweets for 7500 ISK. Contact us for more information at reservations@centerhotels.com / + 354 595 8582.

HONEYMOON PACKAGE

Included is a bottle of sparkling-, red or white wine and sweets along with breakfast at Þingholt by Center Hotels. Free upgrade is included based on availability. The price of the honeymoon package is 11250 ISK. Contact us for more information at reservations@centerhotels.com / + 354 595 8582.

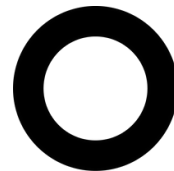

APPLIANCE MANUALS

Below are a few pointers of each appliance in your apartment.

WASHING MACHINE

For apartments with washing machines, kindly refer to the operating manual below that is specific to the brand that is inside your apartment.

Samsung Washer

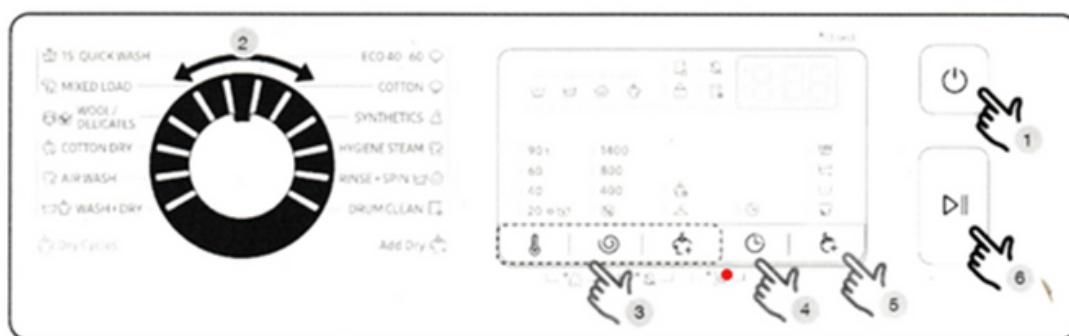

1. Press the POWER to turn on the washing machine.
2. Turn the CYCLE SELECTOR to select a cycle.
3. Change the cycle settings (Temp, Spin, and Dry Option) as necessary.
4. The machine provides one easy to access buttons for DELAY END for your convenience. If you want to use the option, press the corresponding button.
5. To add an option, press OPTIONS. Use the button again to choose a preferred item.
6. Press START/PAUSE.

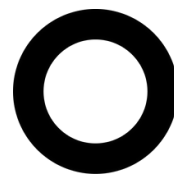

APPLIANCE MANUALS

Elvita washer & dryer

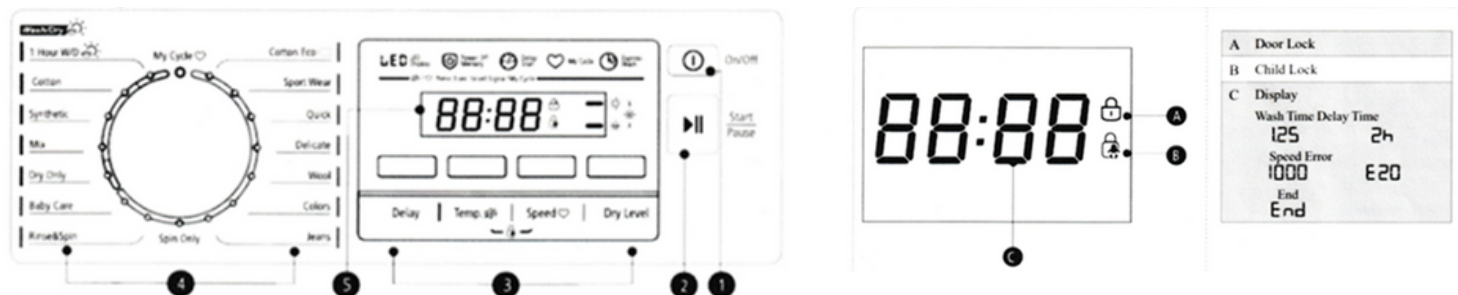

Please note that this chart is for reference only; your appliance may differ slightly.

- On/Off - Turns appliance on or off.
- Start/Pause - Press the button to start or pause the washing cycle.
- Option - This allows you to select an additional function and will light up when selected.
- Programs - Available to the laundry type
- Display - The display shows the settings, estimated time remaining, options, and status messages for your appliance. The display will remain on throughout the cycle.

Program list:

- 1 timme tvatt/tork - 1 Hour wash & dry
- Bomull - Cotton
- Syntet - Synthetic
- Mixade meterial - Mixed clothes
- Tvatt och tork - Wash and dry
- Endast tork - Only dry
- Skj-ljprogram - Rinse program
- Centtrifugering - Centrifugation
- Mitt val - Custom program
- Kort 15 min - 15 minute quick program
- 20 C - 20 celcius cold program
- Sportklader - Sports clothes program
- Jeans - Jeans program
- Ylle - Wool program
- Eco 40-60 - Eco program
- Intensiv - Intensive long duration program

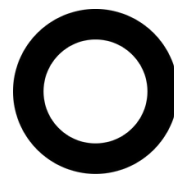

APPLIANCE MANUALS

Whirlpool

HOW TO USE THE APPLIANCE

FIRST TIME USE

Remove any manufacturing debris:

- Select the "Cotton"  programme at a temperature of 60°C.
- Pour a small quantity of detergent powder into the main wash compartment **II** of the detergent dispenser (maximum 1/3 of the quantity the detergent manufacturer recommends for lightly soiled laundry).
- Start the programme **without adding any laundry** (with empty drum).
- See section "DAILY USE" for more information on how to select and start a programme.

DAILY USE

PREPARING THE LAUNDRY



Empty pockets

- Coins, paper clips, etc. could damage the load and the washing machine components.
- Tissues will break down during the wash cycle, and the fragments will have to be subsequently removed by hand.



Close all zippers, buttons, and hooks. Tie all ribbons or belts

- Insert the smaller garments (e.g. nylon hosiery, belts, etc.) and garments with hooks (e.g. braziers) into a fabric bag or a pillowcase with a zipper. Remove any rings from curtains, or else place the curtains inside a fabric bag together with the rings.



Fabric type / Symbol on the wash label

- Cottons, mixed fibres, easy care/synthetics, wool, handwash items.
- Colour
Separate coloured and white items. Wash new coloured articles separately.
- Size
Wash items of different sizes in the same wash load, to improve washing efficiency and distribution of the articles in the drum.
- Delicates
Wash delicate items separately; they require gentle treatment.

HOW TO USE THE WASHING MACHINE

1. Load laundry



Open the door and load the laundry. Load the articles one at a time loosely into the drum, without overfilling. Observe the load sizes given in the "PROGRAMME CHART" table. Overloading the machine will result in unsatisfactory washing results and creased laundry.

2. Close door





Make sure that no laundry gets stuck between door glass and rubber seal. Close the door so that you can hear it click shut.

3. Open water tap



Make sure that the washing machine is connected to the water mains. Open the water tap.

Switch on washing machine

Press the "ON/OFF" , the "Start/Pause"  lamp flashes slowly.

4. Set the desired programme

P Select the required programme with the "Programme selector" dial. The duration of the wash cycle is shown on the display. The washing machine automatically displays the maximum temperature and spin speed settings possible for the selected programme. Adjust the temperature and/or spin speed settings if needed with the relative buttons.

Change temperature, if needed



Press the "Temperature"  button to progressively lower the temperature setting until cold wash has been set ("--" will be shown on the display). Pressing the button again sets the highest possible setting.

Change spin speed, if needed



Press the "Spin"  button to progressively decrease the spin speed until the spin cycle is turned off ("0" will be shown on the display). Pressing the button again sets the highest possible setting.

Select options, if needed



Press the button to select the option; the respective symbol on display illuminates. Press the button again to cancel the option; the light extinguishes.

! If the selected option is incompatible with the programme set, the incompatibility will be signalled by a buzzer (3 beeps) and the corresponding indicator light will flash.

! If the selected option is incompatible with another previously set option, only the most recent selection will remain active.

**center
hotels**

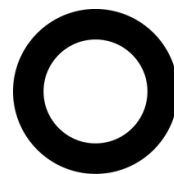

APPLIANCE MANUALS

5. Add detergent



Pull out the detergent dispenser and add detergent (and additives/softener) into the relative compartments as described in section "DETERGENT DISPENSER". Observe the dosing recommendations on the detergent pack.



Correct dosing of detergent / additives is important, because:

- it optimizes the cleaning result
- it avoids irritating residues of surplus detergent in your laundry
- it saves money by avoiding waste of surplus detergent
- it protects the washing machine by avoiding calcification of components
- it respects the environment by avoiding unnecessary environmental burden.

6. Delaying the start of a programme

- To set a programme to start at a later time, see the section "OPTIONS/ START DELAY"



7. Start programme

- Press the "Start/Pause" . The relative indicator lamp illuminates, the door locks and the "Door locked"  indicator lights up.
- To avoid overflow, do not open the detergent dispenser during a running programme anymore.
- The remaining programme duration can vary. Factors like unbalance in the wash load, or foam formation, can have an effect on the programme duration.

8. Change the settings of a running programme, if needed

You can still change the settings while a programme is running. The changes will be applied, provided the respective programme phase has not finished yet.



To change the settings of a running programme:

- Press "Start/Pause"  to put the running programme on pause.
- Change your settings.
- Press "Start/Pause"  again to continue the programme.



If you have changed the programme, do not add detergent for the new programme.

To prevent that a running programme is changed by accident (for instance by children), use the "Key lock"  (see section "FUNCTIONS").



Pause a running programme and open the door, if needed

- Press "Start/Pause"  to pause a running programme.
- Provided water level or temperature is not too high, the "Door locked"  indicator light turns off. You can open the door, for example to add more laundry, or to remove laundry which was loaded by mistake.
- Press "Start/Pause"  to proceed with the programme.

9. Cancelling a running programme, if needed

- Press and hold the "ON/OFF"  button until the washing machine stops.
- If the water level and temperature are low enough, the door unlocks and may be opened.
- The door remains locked if there is water in the drum. To unlock the door, switch the washing machine on, select the "Spin & Drain"  programme and turn the spin option off by setting the spin speed to "0".
- The water is emptied and the door unlocks at the end of the programme.

10. Switch off the washing machine after programme End

- At the end of the cycle, the message "END" is shown on the display.
- The door can only be opened when the symbol "Door locked"  light turns off.
- Check that the "Door locked"  indicator is off, then open the door and take out the laundry.
- Press "ON/OFF"  to switch the washing machine off.

To save energy, if the washing machine is not switched off manually with the button, it turns off automatically approximately 30 minutes after the end of the programme. Leave the door ajar to let the interior of the washing machine to dry.

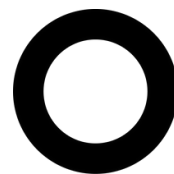

APPLIANCE MANUALS

PROGRAMME CHART

Maximum load 8 kg Power input in off mode 0.5 W / in left-on mode 8 W								Detergents and Additives			Recommended detergent		Residual dampness % (***)	Energy consumption kWh	Total water lt	Laundry temperature °C		
Wash cycle	Temperature		Maximum spin (r.p.m.)	Drying	Max. load for washing (kg)	Max. load for drying (kg)	Duration (h : m)	Prewash	Wash	Fabric softener	Powder	Liquid						
	Setting	Range																
								I	II	☼								
MIXED	40°C	☉ - 40°C	1000	✓	8,0	6,0	**	-	●	○	-	✓	-	-	-	-	-	
WHITE	60°C	☉ - 90°C	1400	✓	8,0	6,0	2:45	● (90°)	●	○	✓	-	49	0,90	90	55	-	
COTTON (2)	40°C	☉ - 60°C	1400	✓	8,0	6,0	3:55	-	●	○	✓	✓	49	1,40	105	45	-	
ECO 40-60 (1)	40°C	40°C	1351	✓	8,0	6,0	3:30	-	●	○	✓	✓	53	0,77	54	33	-	
			1351	✓	4,0		2:45	-	●	○	✓	✓	53	0,65	52	36	-	
			1351	✓	2,0		2:10	-	●	○	✓	✓	53	0,45	37	33	-	
DELICATES	30°C	☉ - 30°C	-	✓	1,0	1,0	**	-	●	○	-	✓	-	-	-	-	-	-
SYNTHETICS (3)	40°C	☉ - 60°C	1200	✓	4,0	4,0	2:55	-	●	○	✓	✓	35	0,80	55	43	-	
STEAM REFRESH	-	-	-	-	2,0	-	**	-	-	-	-	-	-	-	-	-	-	-
SPIN & DRAIN *	-	-	1400	✓	8,0	6,0	**	-	-	-	-	-	-	-	-	-	-	-
RINSE & SPIN	-	-	1400	✓	8,0	6,0	**	-	-	○	-	-	-	-	-	-	-	-
RAPID 30'	30°C	☉ - 30°C	800	-	4,5	-	0:30	-	●	○	-	✓	71	0,20	45	27	-	
20°C	20°C	☉ - 20°C	1400	✓	8,0	6,0	1:50	-	●	○	-	✓	49	0,16	90	22	-	
WOOL	40°C	☉ - 40°C	800	✓	2,0	2,0	**	-	●	○	-	✓	-	-	-	-	-	-
WASH & DRY 45'	30°C	30°C	1400	✓	1,0	1,0	**	-	●	○	-	✓	-	-	-	-	-	-
WASH & DRY 90'	30°C	30°C	1200	✓	1,0	1,0	**	-	●	○	-	✓	-	-	-	-	-	-
ECOCOTTON (4)	60°C	60°C	1400	✓	8,0	6,0	3:45	-	●	○	✓	✓	53	1,04	60	-	-	

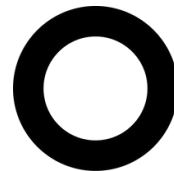

APPLIANCE MANUALS

DISHWASHER

- Load dishes
 - Remove all food scraps and load the dishes
- Add detergent
- Check rinse aid
- Press the POWER button
- Select a wash program
- Select "Eco" (optional)
- Check
 - Ensure there is nothing obstructing the spray arm. The drain filter must be level with the filter plate.
- Start
 - Close the drawer and press the "Play/pause" button.
- Finish
 - The dishdrawer will beep six times to indicate the end of the wash program. At the end of the wash program the drying fan will continue to run for a set time or until the drawer is opened. The fan assists with drying and uses negligible amounts of energy. It is normal for some water to remain in the drain filter area after the wash program, you may find both drawers draining simultaneously. This is normal.

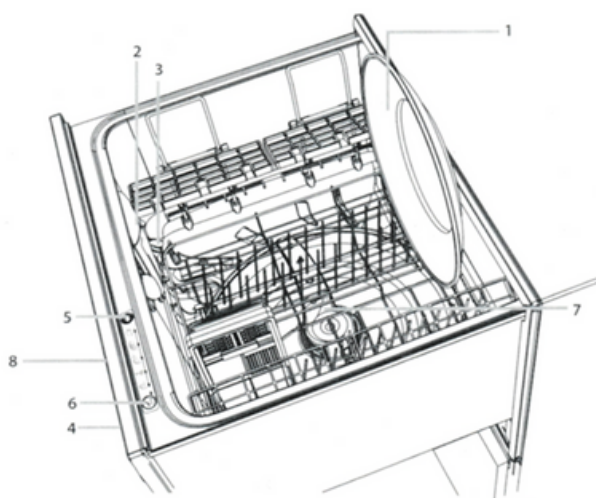

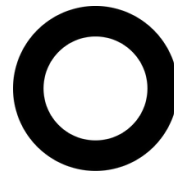

APPLIANCE MANUALS

ELECTRIC OVEN

All apartments are equipped with an electric oven. There are different types of electronic ovens inside the apartments.

A.



1. Press the left knob and select the preferred setting
2. Press the right knob and select preferred temperature
3. Press the 'check' button to adjust additional settings like power (W) and time
4. Press the start button to begin
5. Press the stop button to stop the oven

B.



1. Select the preferred setting with the right knob
2. Select the temperature with the left knob the oven will turn on
3. To adjust the timer, use the middle buttons
4. To turn off the oven, adjust both knobs back to vertical position

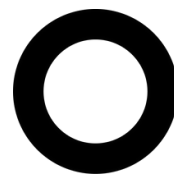

APPLIANCE MANUALS

ELECTRIC STOVE TOP

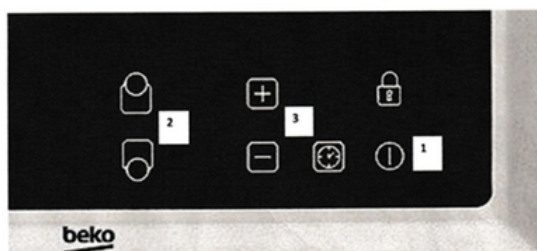

1. Hold the power button to turn the stove on
2. Select the preferred stove
3. Adjust heat
4. Hold the power button again to turn the stove off
5. If the stove shows the letters 'LO' it means that the child lock safety is on. Push and hold the lock symbol for a few seconds to unlock it.

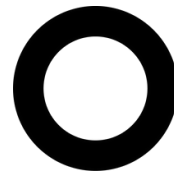

CLOSE BY

SUPERMARKETS

Kronan

Hallveigarstigur 1, 101, 101 Reykjavík

Open: Monday - Sunday 9am -9pm,

Distance: 2 minute walk

Bonus

Laugavegur 59 Kjörgarður, 101 Reykjavík

Open: Monday - Sunday 10am -8pm,

Distance: 10 minutes walk

10/11

Austurstræti 17, 101 Reykjavík

Open: Monday - Sunday 24 hours

Distance: 5 minutes walk

PHARMACIES

Lyfja

Hafnarstræti 19, 101 Reykjavík

Open: Monday - Friday 0900am - 6pm Saturday 11am - 4pm Closed: Sunday

Distance 6 minutes walk

Islands Apotek

Laugavegur 53b, 101 Reykjavík

Open: Monday - Friday 10am - 6pm, Saturday 10am - 4pm Closed: Sunday

Distance: 10 minutes walk

LIQUOR STORE

Vinbuðin

Austurstræti 10a, 101 Reykjavík

Open: Monday - Thursday 11am - 6pm, Friday 11am-7pm Saturday 11am - 6pm Closed: Sunday.

Distance: 5 minutes walk

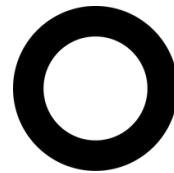

TRANSPORTATION & DIRECTIONS

LOCAL BUS

All buses in Reykjavik are operated by Strætó (this is the yellow bus). There are no other public transport networks in the city, making Strætó the only way to get around Reykjavik without a car or a bicycle.

The buses in Reykjavik start running around 6:30 on weekdays, 7:30 on Saturdays, and 9:30 on Sundays and public holidays. Most routes stop running shortly before or just after midnight, with the exception of the night bus routes which run on Fridays and Saturdays, more information on the night buses can be found later in this article. To find out which bus you need to catch you can use the Straeto website's handy route planner, which is also available in the app, or the timetables for each bus route.

BUS CARDS

Bus tickets can be purchased by downloading the Klapp application however a local number may be required for verification purposes. Alternatively, cash payment can be made directly inside the bus. One way bus ticket costs 490 ISK per person.

- Closest Local bus stop to us is Lækjargata.

TAXI

Official taxi company in Iceland is Hreyfill. To book a taxi, guests can call +354 588-5522 (international phone). Alternatively, guests can download the Hreyfill application.

HOP ON - HOP OFF

Hop On Hop Off bus takes you between 16 conveniently located and interesting stops in Reykjavik. Catch it along Harpa Concert Hall and enjoy a 45 minute circuit trip around the most iconic sites in Reykjavik – hop-on and hop-off at will.

DIRECTIONS TO KEFLAVÍK AIRPORT

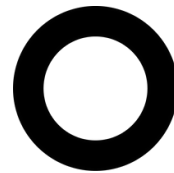

TRANSFER

TO KEFLAVÍK AIRPORT

The duration from Reykjavik to KEF airport is 45 minutes.

Our hotel does not provide airport transfers but there are different options on how to get to Reykjavik from the airport. Please see here below:

You can book the transfer with Airport Direct via the following link, different options are available: bit.ly/AirportDirect_TH

Public Bus 55 (Sdrives between the capital area and Keflavik International Airport every day. For more information and tickets click here.

Another option is a taxi - flexible schedule, quickest option, however, a bit more expensive of course than the buses. The fixed rate for a small taxi is 18,000 - 24,000 ISK depending on day and night rate. You may book the taxi via www.hreyfill.is

Private Transfer: If you are interested in this option, please use the following link to make a reservation: https://bit.ly/private_CH

TO REYKJAVÍK DOMESTIC AIRPORT

This is the main domestic airport serving Reykjavík, the capital of Iceland, located about two kilometers from the city center. To go to Reykjavik Domestic Airport, guests can either take a taxi or walk. The taxi ride is around 7 minutes. Guests can also opt to walk and this will be around 30 minutes.

TO BSÍ BUS TERMINAL (VATNSMÝRARVEGUR ST #10)

To go to BSI Bus Terminal, guests can either purchase a Flybus ticket from Reykjavik Excursions or take a taxi. The taxi ride is around 5 minutes. Guests can also opt to walk and this will be around 15 minutes.

TO REYKJAVÍK TERMINAL (SKÓGARHLÍÐ 10, 105 REYKJAVÍK)

To go to Reykjavik Terminal, guests can either purchase a SmartBus Hotel Connection ticket from Airport Direct or take a taxi. The taxi ride is around 8 minutes. Guests can also opt to walk and this will be around 30 minutes.

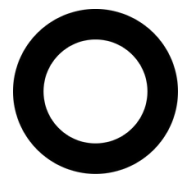

PLACES TO VISIT IN ICELAND

POPULAR TOURS

The most popular tours in Iceland are The Golden Circle and the South Coast. On the Golden Circle tour you will visit breathtaking sites such as Gullfoss, Geysir and Þingvellir National Park. On the South Coast Tour you will visit Seljalandsfoss, Skógafoss, Reynisfjara and Vik just to name a few.

Our personal favorite is the Snæfellsnes Peninsula Tour. The peninsula is often nicknamed 'Iceland in Miniature' due to the wealth and diversity of natural features found there. Also, this is a popular filming location of some well-known television shows and movies. For a livelier experience you can book these tours as part of a group in a large coach with companies like Reykjavik Sightseeing or Reykjavik Excursions.

If you are looking for something a little more private like a minibus tour, that's what Reykjavik Outventure or EastWest are known for. These companies are for you if you are willing to make your holidays extra special and you appreciate a personal touch during the trip.

Finally, there is the SuperJeep and Mountaineers of Iceland if adventure and fun are at the top of your list. You will travel on either a super jeep or monster truck, and they are great trips for those who want to get off the beaten track with a knowledgeable and experienced driver.

A lot of companies offer combo tours with ATV, buggy or snowmobile rides during the day.

All the tours mentioned can be booked directly from the following link
<https://www.centerhotels.com/en/tours>

LAGOONS

You can also choose to book a relaxing hot bath in one of the spas around the country, such as the Secret Lagoon or Fontana Spa on the Golden Circle, Sky Lagoon in Reykjavik, Hvammsvik in Mosfellsbær or The Blue Lagoon on the way to the airport. You can book any of these lagoons via <https://www.centerhotels.com/en/tours>

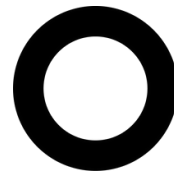

PLACES TO VISIT IN ICELAND

ADVENTURE & EXOTIC TOURS

There is a very extensive offer of active tours, from glacier walks and climbing, to snorkeling at Silfra and the amazing horse riding. For glacier walks and snorkeling you may check out the tour companies: Icelandic Mountain Guides or Dive.is. If you love horse riding, Ishestar or Eldhestar are the two most established horse riding operators.

If you are after a more exotic experience, we can recommend ice cave walks or inside the volcano tours.

If good weather and good sea conditions are forecast, Whale Watching in the Faxaflói Bay is a very good option! Elding and Special Tours are both based at the Old Harbour and offer standard and rib boat tours. It is a great way to be close to nature while having stunning views on the city as well as the mountains.

REYKJAVÍK CITY TOURS & MUSEUMS

Reykjavik itself also has plenty of activities to offer, if you are planning to spend a day exploring the capital you can book a walking tour. Food and beer tasting tours are also available and in fact these are the most highly rated tours on TripAdvisor in Iceland.

For museums we have special section in the link above called Explore Reykjavik

There you can find a lot of interesting museums, and activities most of them within walking distance from the hotel. Just to name a few, Saga Museum and National Museum have great displays of history and heritage in Iceland. Some very nice family activities are The Perlan, Fly Over Iceland, and Whales of Iceland are more interactive museums, great for kids and teenagers as well. They all have exhibitions explaining natural phenomena, nature and wildlife.

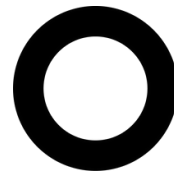

PLACES TO VISIT IN ICELAND

TOUR PICK UP POINT

The nearest pick-up and drop off place from our Þingholt Apartments is called: Bus Stop 3 Lækjargata (<https://busstop.is/>) and it is right in front of Hard Rock Cafe.

Most tour companies pick up the guests from Bus Stop 3 - Lækjargata, just a 3 minute walk from the hotel. Occasionally, operators offer pick up from bus stop 6 - Culture House. Guests must always reconfirm with the tour operator 24 hours in advance the pick up time as well as the pick up location to avoid any confusion on the day.

FAVORITE RESTAURANTS

- Grillmarket (grillmarkadurinn.is/en/menu/dinner-menu/). Considered one of the best ones in town, the main characteristic is the close relationship with local farmers, so you will only find what's in season.
- Kopar (koparrestaurant.is/en/menu/dinner-menu/). Located by the old harbour area, it's a lovely place for both a quick lunch or a more relaxing dinner.
- Fish company (fiskfelagid.is/en/dinner/). A cozy place with a great fish menu
- Islenski Barin (<https://islenskibarinn.is/>). A casual place offering the local experience.
- Sushi Social (<http://sushisocial.is/?lang=en>). Personally, it is the best sushi place in town.
- Kastrup (<https://www.kastrup.is/>) a modern Nordic-style bistro in the heart of Reykjavík offering sumptuous Icelandic delicacies as well as popular dishes like duck confit.

We are also proud to offer you to enjoy the restaurants or bars located in our Hotels. [Jørgensen Kitchen & Bar](#), [Lóa Restaurant](#), [Sky Bar](#), and [Hédinn Kitchen & Bar](#).

EVENTS

Every Thursday night you can find Live Jazz and Happy Hour from 18:00-20:00 at our sister hotel Miðgarður by CenterHotels.

A detailed schedule of the events in the capital area can be found on The Reykjavik Grapevine (grapevine.is) and on What's On (whatson.is): you can choose between live music, stand up comedy in English, theater plays and much more.

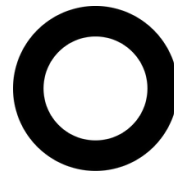

GUEST FEEDBACK AND REVIEW

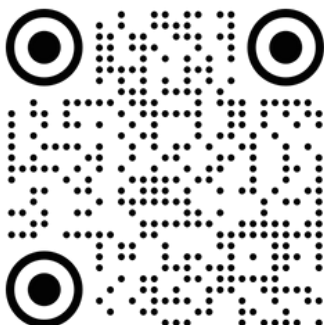

We welcome all forms of reviews and feedback. Please feel free to leave us feedback.

We wish you a wonderful stay.